

PLEASE FIND OUR FULL OFFER:

FLAT BOTTOM SILOS
FOR GRAIN STORAGE

HOPPER BOTTOM SILOS
FOR GRAIN STORAGE

DEVICES FOR GRAIN TRANSPORTATION

FEED SILOS AND EQUIPMENT
FOR ON-FARM FEED MILLS

AGRICULTURAL SHELTER TYPE MULTI_10X12



SHELTER MULTI_10X12/3,5 + MULTI_10X12/4,5
OPTION NUMBER V



SET OF 3 SHELTERS MULTI_10X12/4,5



SET OF 4 SHELTERS MULTI_10X12/4,5
2 TIMES OPTION NUMBER IV



SET OF 4 SHELTERS MULTI_10X12/4,5
WITH WALL ENCASEMENT, THE TRANSOM WINDOWS,
AND THE GATES



SET OF 2 SHELTERS MULTI_10X12/4,5
WITH WALL ENCASEMENT



SHELTER MULTI_10X12/4,5
OPTION NUMBER II
WITH GRAIN DRYER



SET OF 2 SHELTERS MULTI_10X12/4,5
OPTION NUMBER IX

QUALITY

EXPERIENCE

PROFESSIONALISM



AGRICULTURAL SHELTERS TYPE MULTI_10X12



BIN Sp. z o.o.
ul. Narutowicza 12
87-700 Aleksandrów Kujawski
POLAND

+48 54 282 88 05
export@bin.agro.pl
www.bin.agro.pl



- The MULTI_10X12 storage shelter is mainly dedicated for storing agricultural equipment, agricultural products and building materials.
- Shelters are available in two versions of usable height: MULTI_10X12/3,5 - 3,5m, MULTI_10X12/4,5 - 4,5m.
- The shelter has a modular structure, that is why it can be adapted to the customer's needs and easily expanded if necessary.
- Structure of the shelter is hot dip galvanized.
- The roof of the shelter is covered with 0,7mm thick galvanized trapezoidal sheets of steel grade T50. Screens and flashings are made of 0,7mm thick varnished sheets of steel in silver colour. The fasteners are made of 2,5mm thick and 1,5mm thick galvanized sheets of steel.
- The shelter can be encased with the walls. The walls of the shelter are made of trapezoidal sheet of steel grade T35. The walls can be fitted with transom windows and a gate.
- There is a possibility of a different combination of shelters on individual customer request if it is possible in terms of design solutions and if it is possible in accordance with the technology of manufacturing.

MULTI_10X12/3,5

MULTI_10X12/4,5

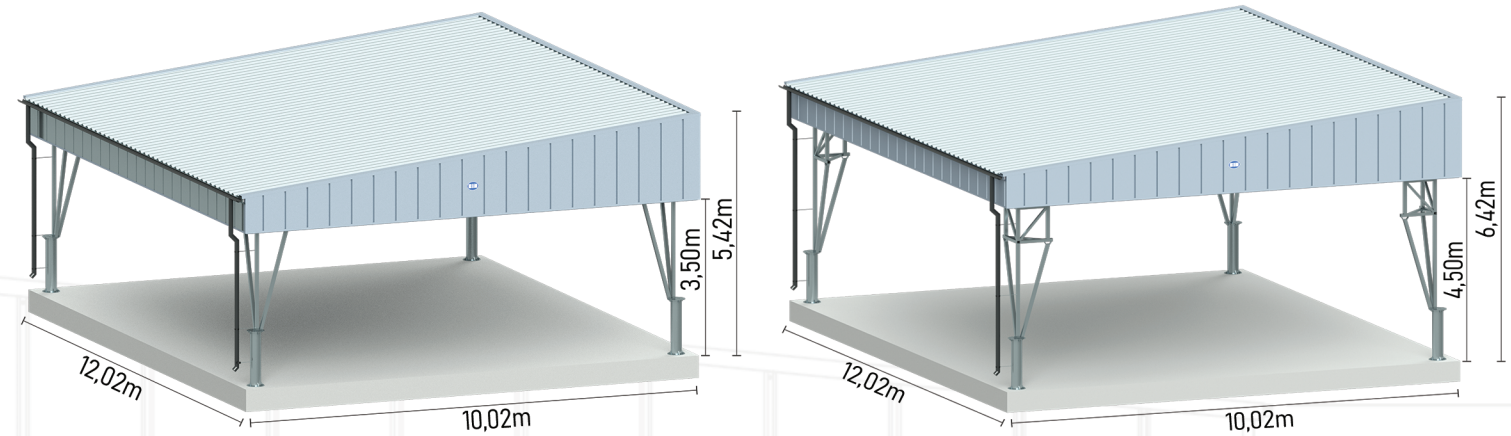

BIN OPTIONAL EQUIPMENT OF THE AGRICULTURAL SHELTERS

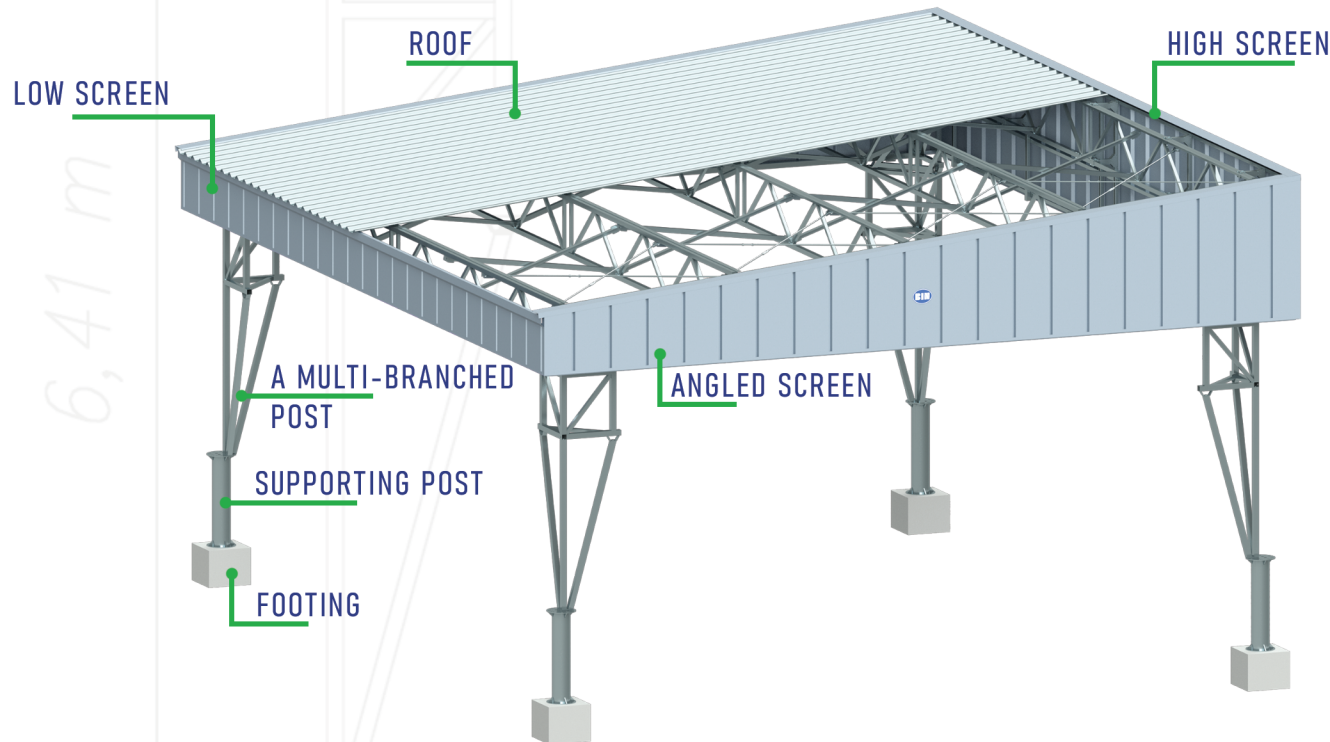

BIN WALLS

The structure of the shelter allows encasing it with the walls. The walls are made of trapezoidal sheets of steel grade T35. The transom windows and the gate can be installed in the walls.

BIN GATES

Gates are selected due to arrangements with the customer. Most often are used a folding doors 4,5 metres wide and 3,3 metres high for the lower shelter and a folding doors 4,3 metres high for the higher shelter.

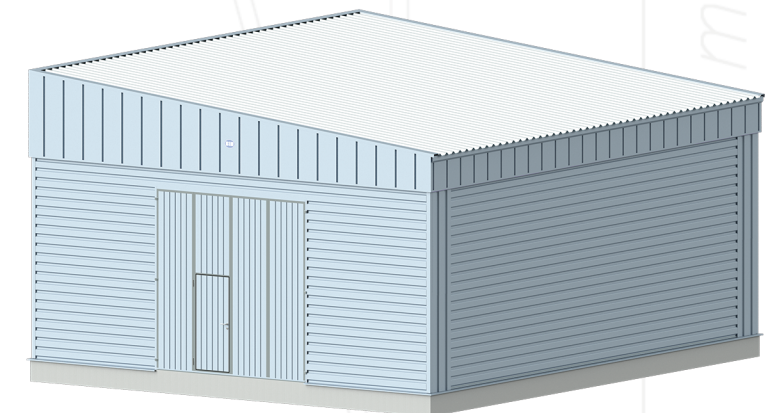
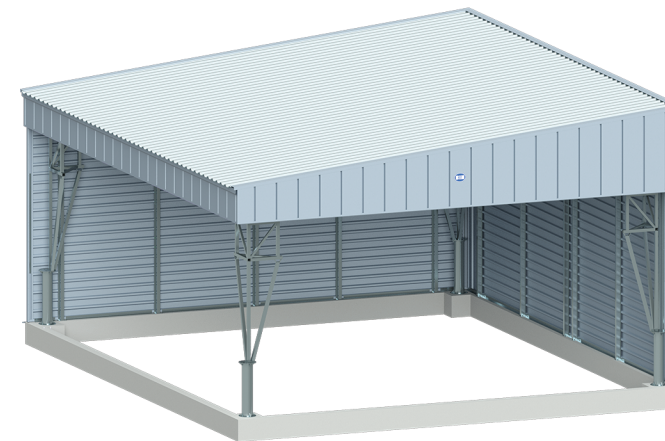

BIN TECHNICAL PARAMETERS OF THE SHELTER MULTI_10X12

MULTI_10X12/4,5

MULTI_10X12/3,5

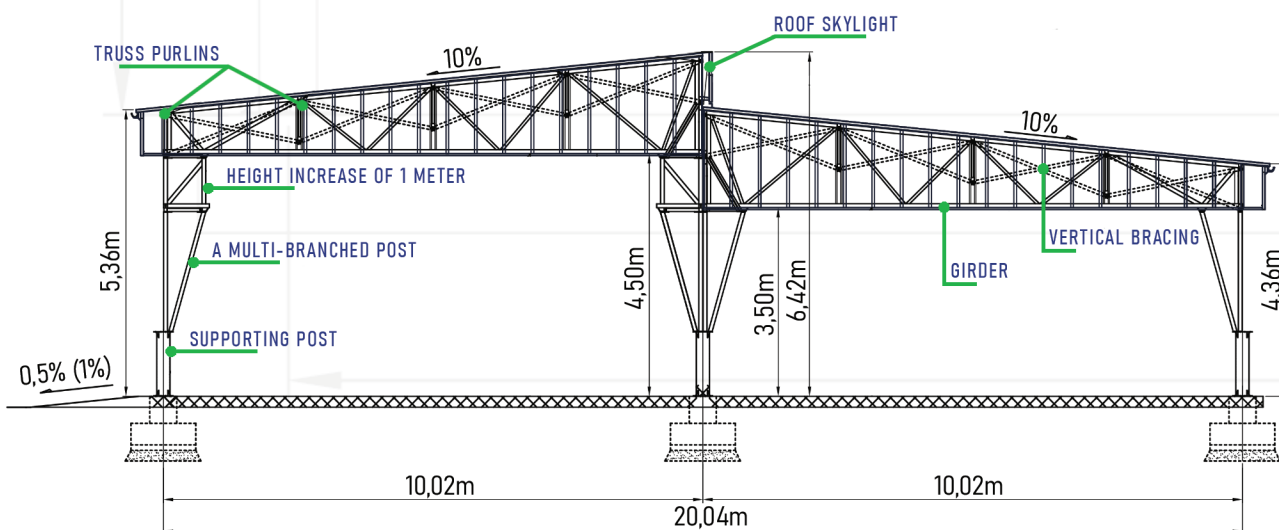

BIN TRANSOM WINDOWS

Standard locations of the transom windows are in the walls 12 metres long and in the skylight. It is allowed, also, to use them in the walls 10 metres long.

BIN GUTTERS

Gutters are placed near the low screen. Downpipes are located at the posts every 12m.

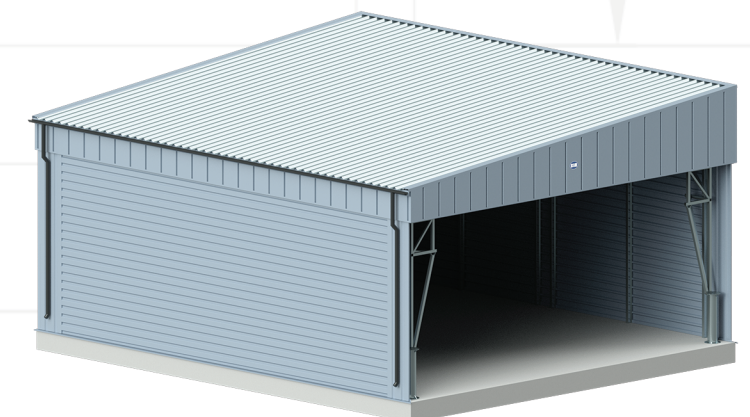
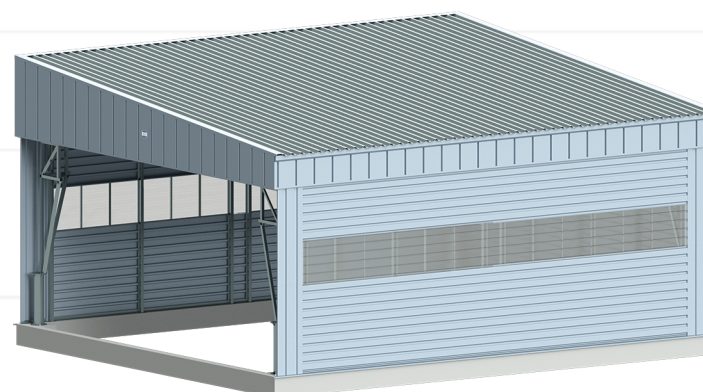

BIN COMBINATIONS OF SHELTERS **multi 1012**

BIN OPTION I BASIC SHELTER MULTI_10X12/3,5

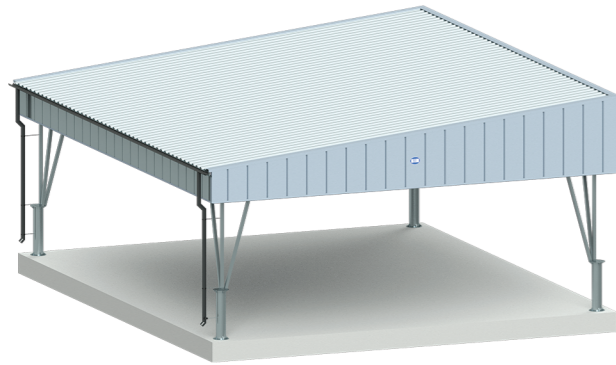

USABLE AREA - 120m²
 USABLE HEIGHT - 3,5m
 BUILDING AREA * - 126m²

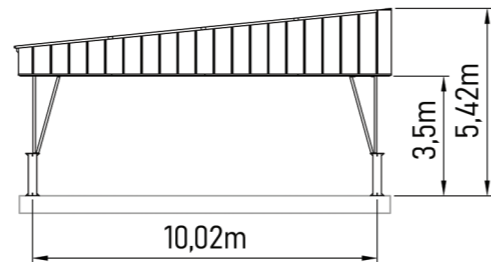

BIN OPTION II BASIC SHELTER MULTI_10X12/4,5

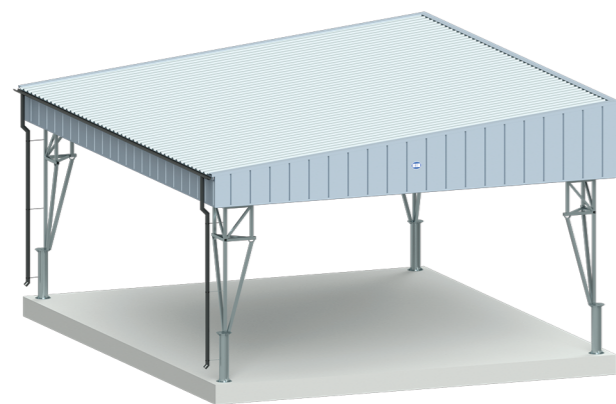

USABLE AREA - 120m²
 USABLE HEIGHT - 4,5m
 BUILDING AREA * - 126m²

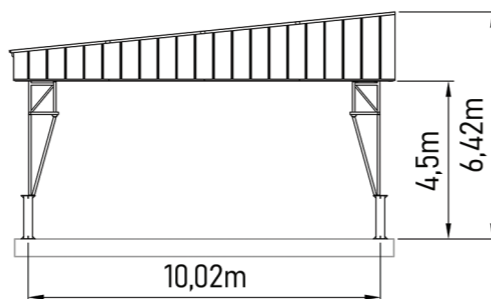

BIN OPTION III SET OF 2 SHELTERS MULTI_10X12/3,5

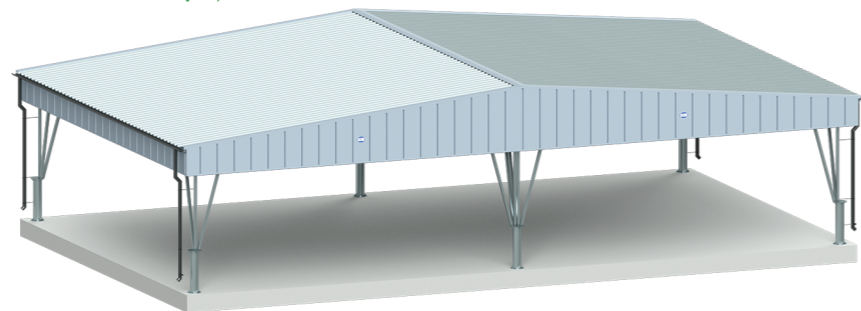

USABLE AREA - 240m²
 USABLE HEIGHT - 3,5m
 BUILDING AREA * - 256m²

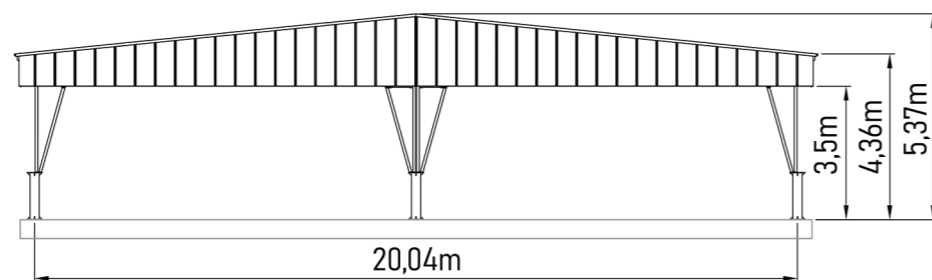

BIN OPTION IV SET OF 2 SHELTERS MULTI_10X12/4,5

USABLE AREA - 240m²
 USABLE HEIGHT - 4,5m
 BUILDING AREA * - 256m²

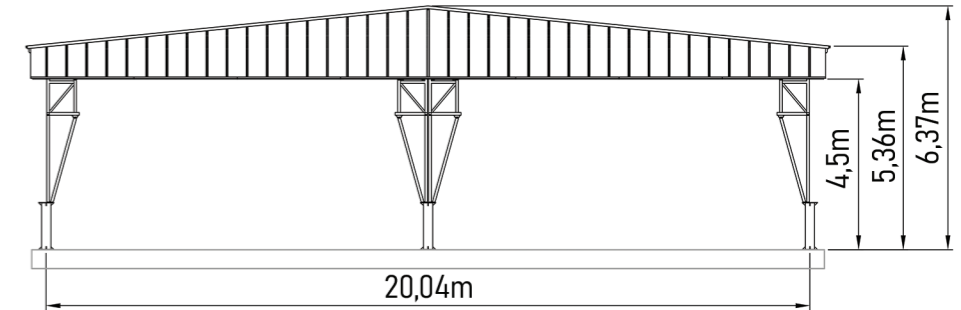
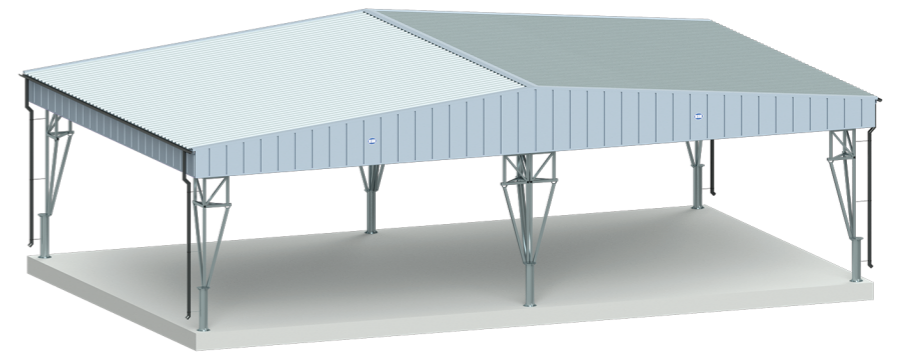

BIN OPTION V SHELTER MULTI_10X12/4,5 + SHELTER MULTI_10X12/3,5

USABLE AREA - 240m²
 USABLE HEIGHT -
 - 3,5m (120m²) and 4,5m (120m²)
 BUILDING AREA * - 256m²

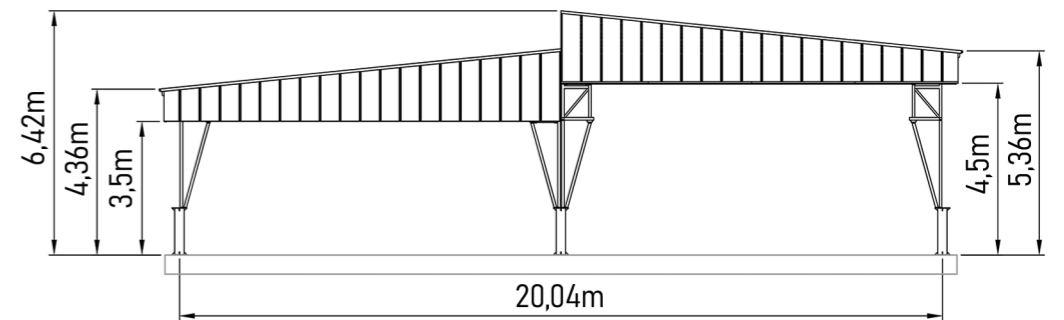
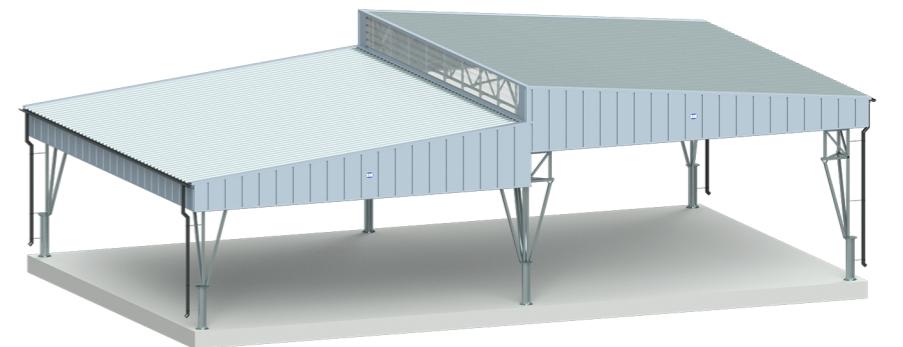

BIN OPTION VI SHELTER MULTI_10X12/3,5 + SHELTER MULTI_10X12/4,5

USABLE AREA - 240m²
 USABLE HEIGHT -
 - 3,5m (120m²) and 4,5m (120m²)
 BUILDING AREA * - 256m²

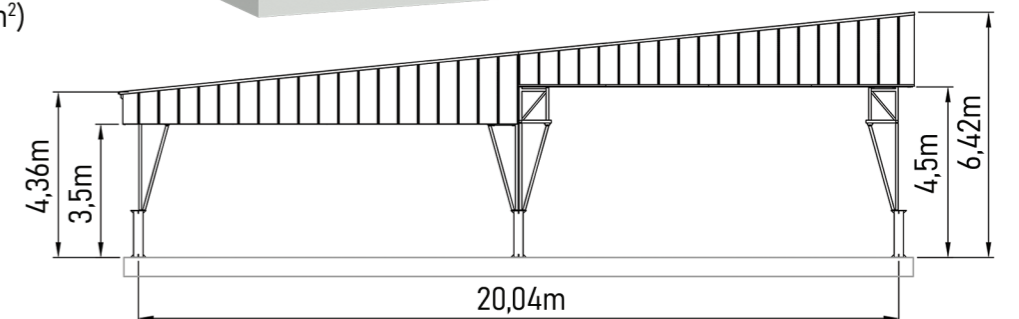
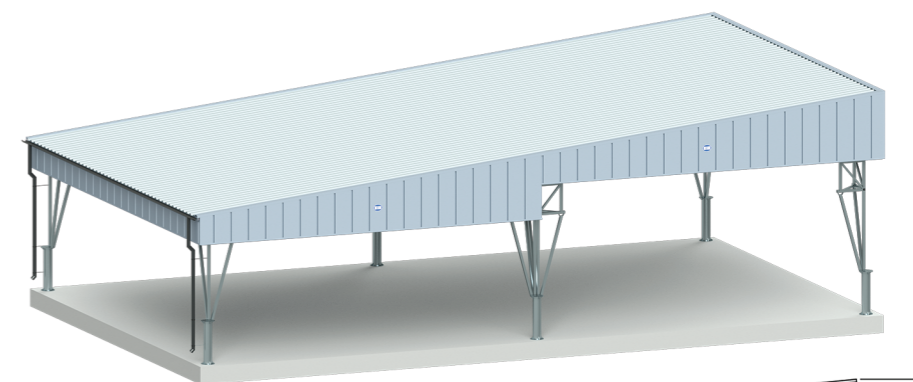

* Building area of a shelter without walls. Please note that the building area of a shelter with the walls will be larger.

* Building area of a shelter without walls. Please note that the building area of a shelter with the walls will be larger.

BIN **OPTION VII SET OF 2 SHELTERS MULTI_10X12/3,5 + MULTI_10X12/4,5**

USABLE AREA - 360m²
 USABLE HEIGHT - 3,5m (240m²) and 4,5m (120m²)
 BUILDING AREA * - 381m²

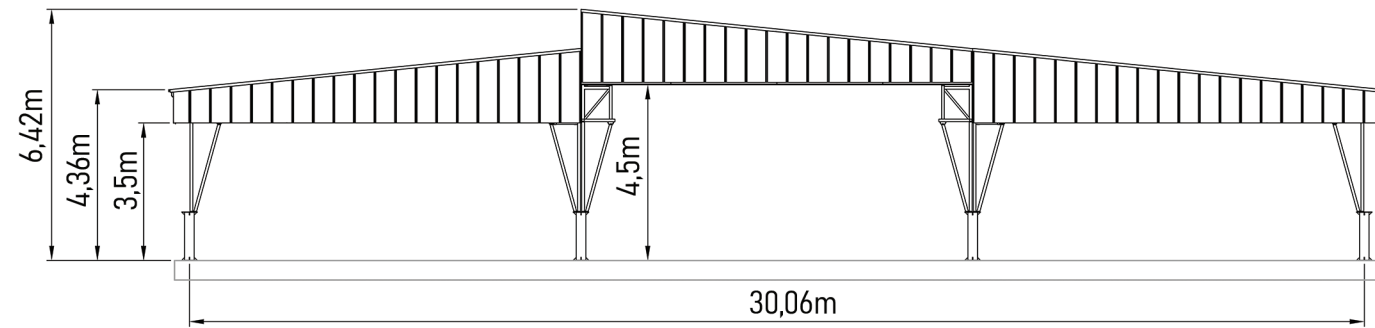
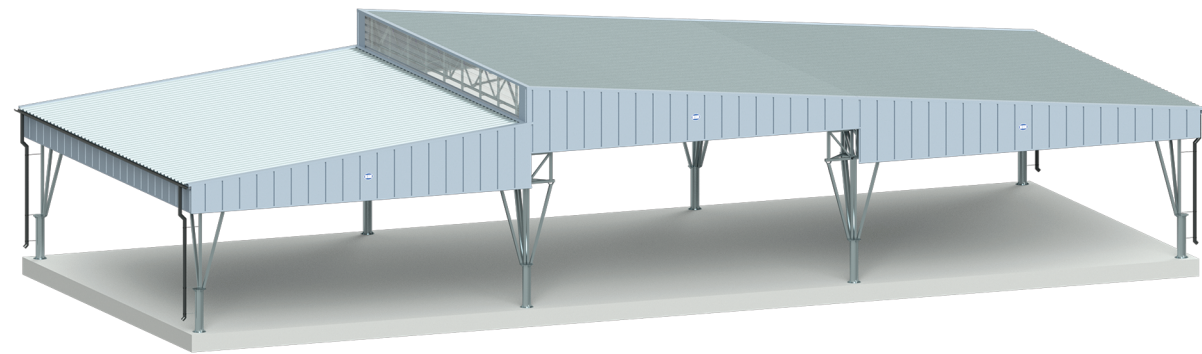

BIN **OPTION IX SET OF 2 SHELTERS MULTI_10X12/4,5**

USABLE AREA - 240m²
 USABLE HEIGHT - 4,5m
 BUILDING AREA * - 257m²

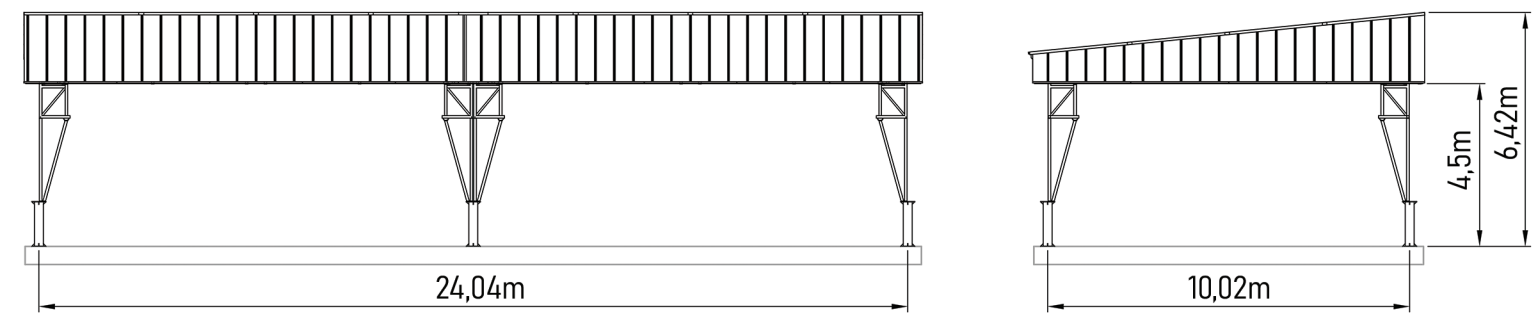
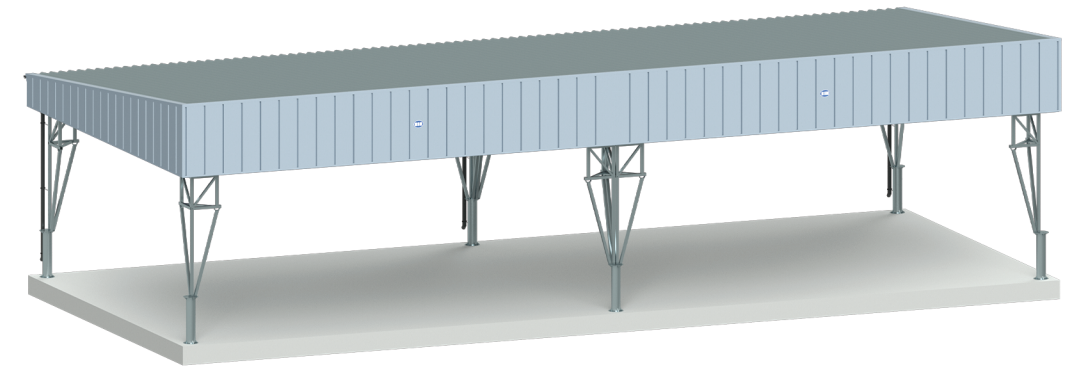

BIN **OPTION VIII SET OF 2 SHELTERS MULTI_10X12/3,5 + 2 SHELTERS MULTI_10X12/4,5**

USABLE AREA - 480m²
 USABLE HEIGHT - 3,5m (240m²) and 4,5m (240m²)
 BUILDING AREA * - 506m²

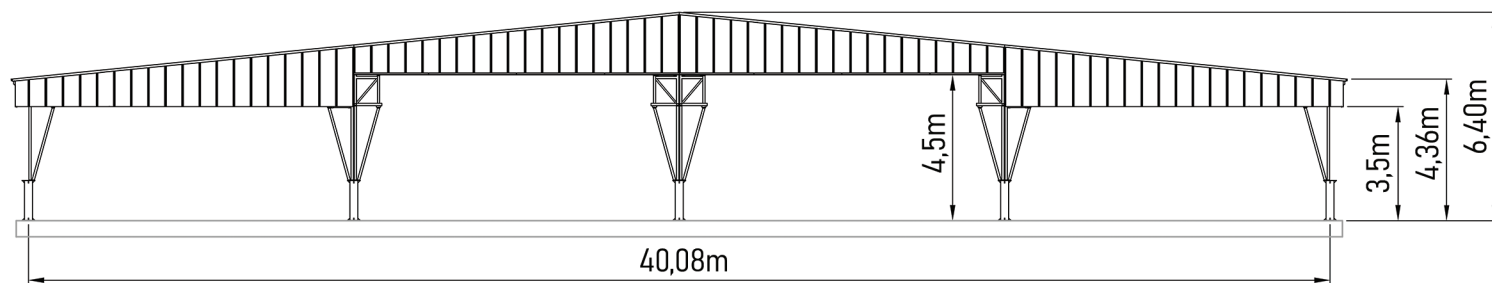
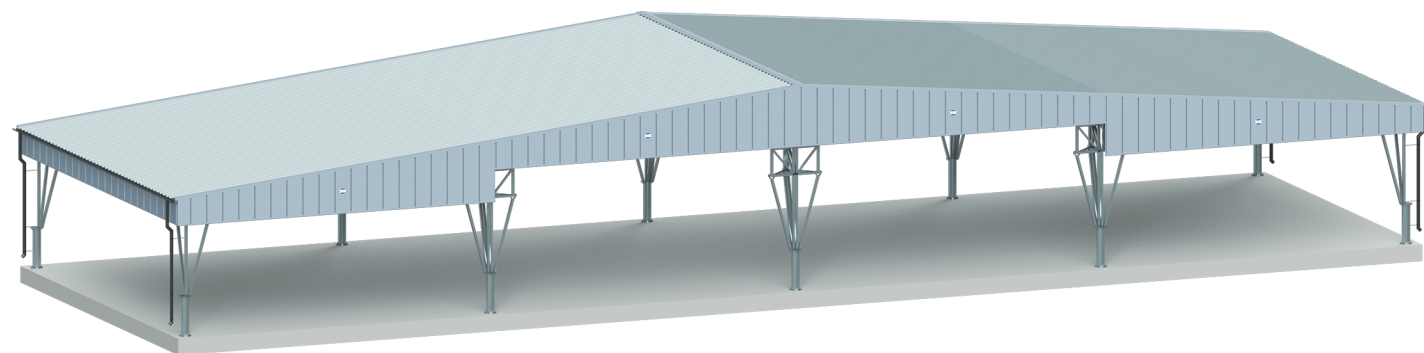

BIN **OPTION X SET OF 2 SHELTERS MULTI_10X12/3,5**

USABLE AREA - 240m²
 USABLE HEIGHT - 3,5m
 BUILDING AREA * - 257m²

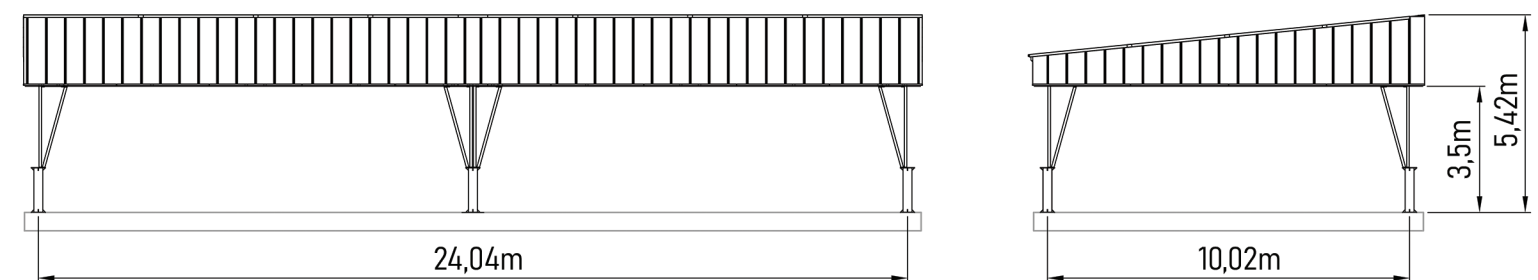
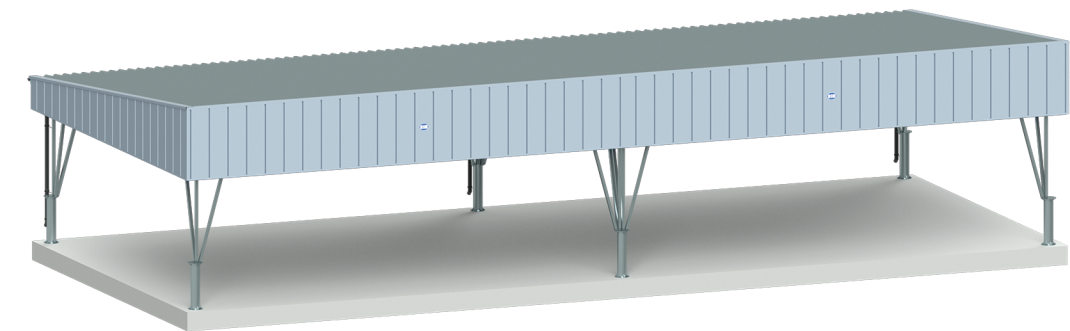

* Building area of a shelter without walls. Please note that the building area of a shelter with the walls will be larger.

* Building area of a shelter without walls. Please note that the building area of a shelter with the walls will be larger.